

Ex9L

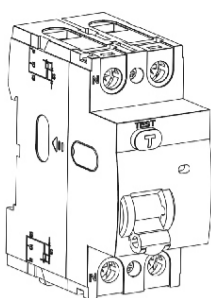

RCCB
 Proudový chránič
 Prúdomý chránič
 Wyłącznik różnicowoprądowy
 Interrupator diferencial
 FI-Schalter
 Interrupteur différentiel
 УЗО
 Diferencijalna zaštitna sklopka

NOARK

Ex9L

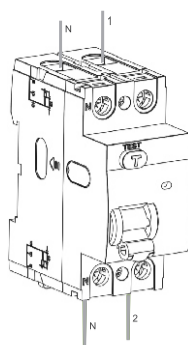

	$\oplus \ominus$ Z2
	1-35mm ²
	2.5Nm

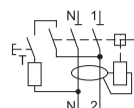

Ex9L

Mounting instructions
 Montážní návod
 Montážne inštrukcie
 Instrukcja montażu
 Instrucțiuni de asamblare
 Montageanweisung
 Instructions de montage
 Инструкция по монтажу
 Monteringsanvisning
 Istruzioni di montaggio
 Instrucciones de montaje
 Ősszeszerelési útmutató
 Uputstvo za montažu

Asennusohjeita
 Montage-instructies
 Instrucões de montagem
 Navodila za montažo
 Οδηγίες Εγκατάστασης
 Инструкции за инсталиране
 Monteringsvejledningen
 Montažu upute
 Surinkimo instrukcijos
 Instalēšanas instrukcijas
 Скупштина упутство
 Paigaldusjuhendid

Ex9L

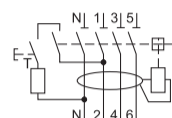
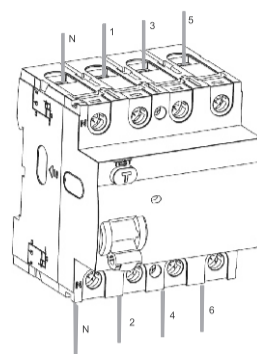

Ex9L

Caution: Installation by electricians only
 Varování: Montáž pouze osobou s elektrotech. kvalifikací
 Varovanie: Montáž iba osobou s elektrotech. kvalifikáciou
 Uwaga: Montaż tylko przez uprawnionych instalatorów
 Atenție: Instalare numai de catre electricieni
 Vorsicht: Montagenur durch Elektrofachkräfte
 Осторожно: Монтаж только электрика
 Upozorenje: Montažu izvodi samo stručno lice

Ex9L

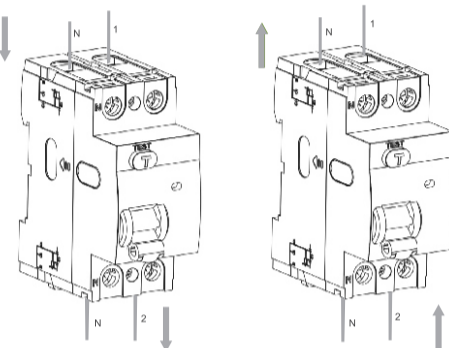

Ex9L

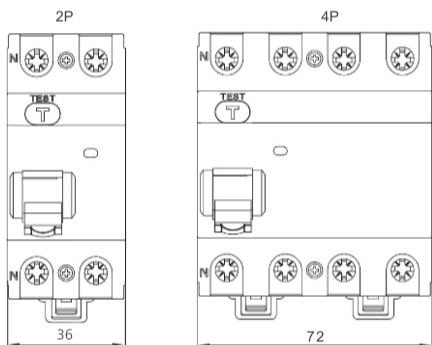

Ex9L

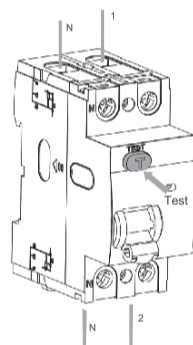

Test monthly
 Testovat měsíčně
 Testovať mesačne
 Test miesięcznie
 Test lunar
 Test månedlige
 Test mensuelle
 Испытание ежемесячно
 Mesečno testirati

Ex9L

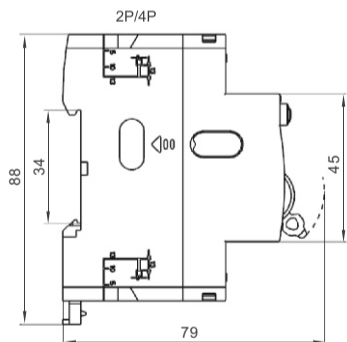

Ex9L

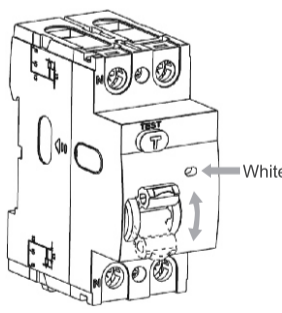

White
 Biłá
 Biela
 Bialo
 Albá
 Weiss
 Blanc
 Белá
 Бела

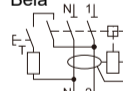

Ex9L

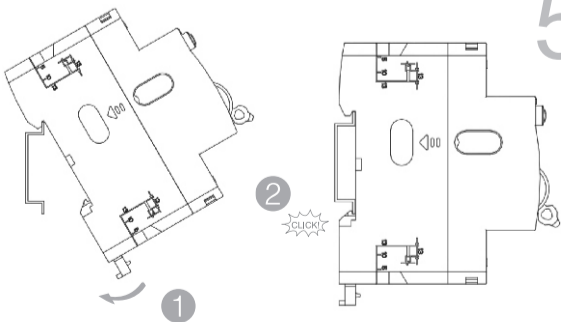

Ex9L

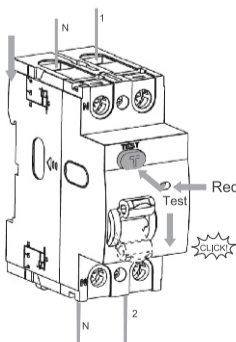

Red
 Červená
 Czerwoný
 Roșu
 Rot
 Rouge
 Красный
 Crvena

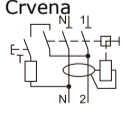

Ex9L

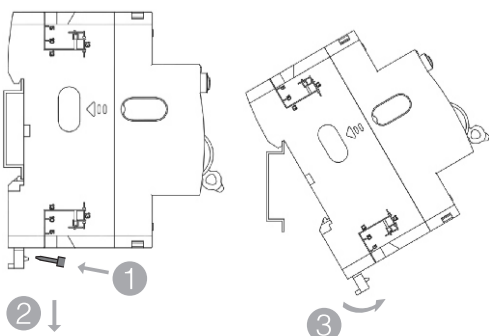

NOARK



Printed with environment-friendly paper
 Copyright Noark. All Rights Reserved
 Manufacturer: NOARK Electric (Shanghai) Co., Ltd.
 3857 Sixian Road, Songjiang District, Shanghai
 Importer: NOARK Electric Europe s.r.o. Sezemická
 2757/2 | 193 00 Praha 9 | Czech Republic
 www.noark-electric.eu
 Z9L201710EU